

Varenummer: 0125081
 Beskrivelse: Seeger låsering SP68
 Fjederstål

Mål

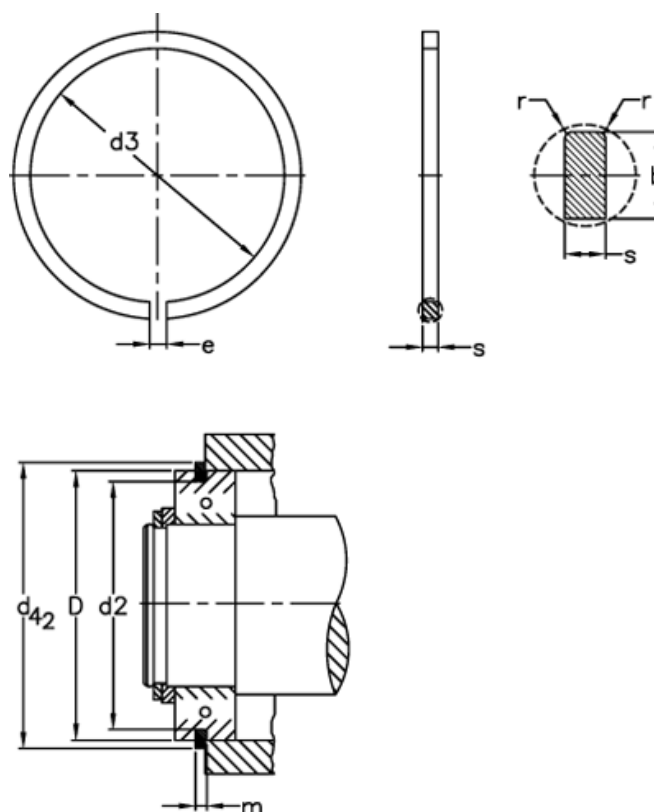

b	= 4.85	FRg kN	= 7.06	tol	= -0.15
Betegnelse	= SP 68	FR kN	= 40.9	tol	= -0.1
D	= 68	g	= 2.5	tol	= -0.50
d2	= 64.82	K kN-mm	= 75.0	tol	= 0.3
d3	= 63.4	m	= 1.90	tol	= 0.8
d42	= 74.6	n abl x 1000	= 4.0	vægt kg/1000	= 12.6
e	= 5	r min	= 0.6		
FN kN	= 55.5	s	= 1.70		